

FLOORING

GOOD TO KNOW

Can be laid on existing floors, except on thick wall-to-wall carpeting. When laying floors, always use NIVÅ floor lining (sold separately). When laying floors on concrete, complement with SPÄRRA plastic sheeting (sold separately).

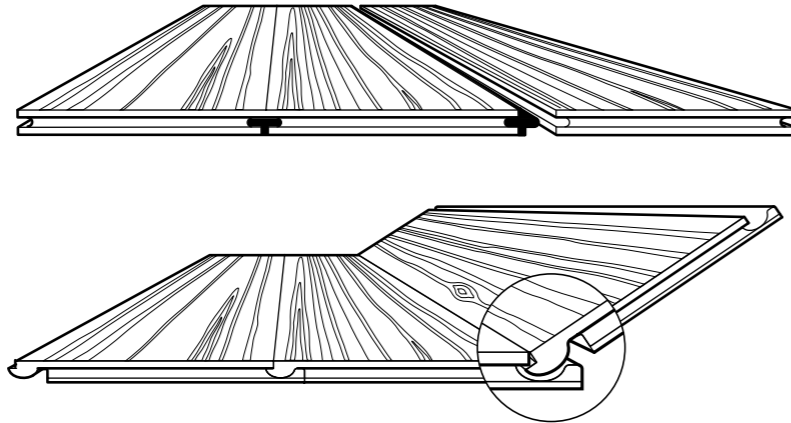

Don't forget the floor

The floor is such an obvious part of your home decoration that it's easy to forget that it's actually the foundation of your entire home. A new floor creates a beautiful base for your furniture and can transform a bland room into a truly harmonious one. We have easy care floors for all tastes and wallets. And for all rooms, except wet rooms. Choose between laminate, wood, sisal, linoleum or polypropylene plastic. They're all easy to lay and will make your home feel like new.

Super easy

It should be easy to lay a floor. That's why all our floors have a simple click system or a smart plastic strip. You can leave the plastic strip visible, if you want the floor to look like a boat deck. Of course, detailed instructions are always included. And we also have most of the accessories and tools you need.

Floors that are easy to lay and clean

Our floors are easy to clean and easy to lay, and we have floors for all rooms, except wet rooms. You can lay the floors on top of most existing floors. No adhesive or special tools are needed. The few tools and floor lining you need are available at your IKEA store. If you should happen to lay the floor incorrectly or damage it – it's easy to take up and replace it – it's easy to take up and replace it. And to clean – just vacuum or wipe with a cloth.

HOW TO LAY YOUR FLOOR

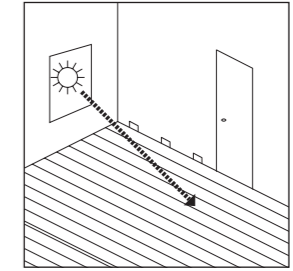
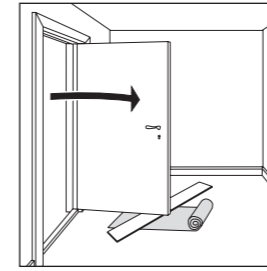

1. First, make sure there is enough space for your underlay material and new floor under any doors.

2. Leave the floor in its packaging for at least 48 hours in the room where you plan to lay it. This way, the floor can adjust to the temperature and the humidity of the room.

3. Make sure that the existing floor is clean, dry and level. If your existing floor is made of concrete, you should always cover it with SPÄRRA plastic sheeting. Then, regardless of the type of floor you are laying on top, put NIVÅ floor lining in place.

4. Clear, detailed instructions on how to lay your floor are included in all floor packages. BALK and KVIST floors are laid by using a plastic strip, which you can choose to have visible or invisible (see illustration A). LÄKT, HEMSE and TUNDRA floors are put together by simply clicking the boards together, one by one (see illustration B).

5. As our floors are made from living material, changes in temperature and humidity can cause them to move. Leave some space along the walls and thresholds using FIXA spacers to accommodate this.

6. The pattern of both wooden and laminate floors looks best if you lay the boards in the direction of the incoming light.

7. Create a nice looking transition between the floor and walls by adding skirting boards! There are skirting boards to match BALK, KVIST, LÄKT and TUNDRA, both in name and appearance. For other floors you can choose any other skirting board to match your floor, for instance PLAN.

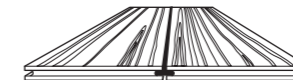

Illustration A: The BALK and KVIST floors can be joined in two different ways – either with an invisible join or the effect of a boat deck.

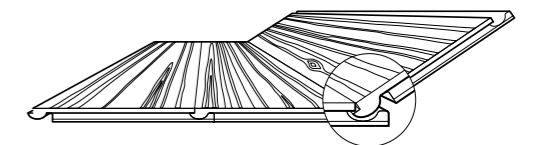

Illustration B: The LÄKT, HEMSE and TUNDRA floors are easily put together by clicking one board to another.



Design and Quality
IKEA of Sweden

CHOOSE THE RIGHT FLOORING FOR THE ROOM

	WOODEN FLOORS:			LMINATE FLOORS:	
	BALK	LÄKT	KVIST	HEMSE	TUNDRA
Livingroom	●	●	●	●	●
Bedroom	●	●	●	●	●
Childrens room	●	●	●	●	●
Hallway/entrance	●		●	●	●
Storage room	●	●	●	●	●
Home office/study*	●	●	●	●	●
Small business/ public office*					●
Price per m ²	SR 187	SR 125	SR 180	SR 66	SR 75

* Protect your floor by using KOLON floor protectors under your work space.

- Floorings are not recommended for humid places such as bathrooms, kitchen, damp cellars and basements and rooms with a floor drain.

LAY OVER ANY TYPE OF SUBFLOOR

Existing floor:	You can keep the old flooring	You need to remove the old flooring	Make sure the floor is clean, dry and level	Use SPÄRRA plastic foil	Use NIVÅ underlay material
Linoleum	●		●		●
PVC	●		●		●
Parquet	●		●		●
Cork	●		●		●
Wood	●		●		●
Stone	●		●		●
Tiles	●		●		●
Wall-to-wall-carpet		●	●		●
Concrete	●		●	●	●
Floor with underfloor heating	●		●		●

- Floorings are not recommended for humid places such as bathrooms, kitchen, damp cellars and basements and rooms with a floor drain.

ALL PARTS AND PRICES

Wooden flooring

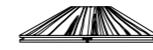

BALK wooden flooring with plastic strip system (strips included). 1.55 m²/pack 10 mm.

Brown	700.805.69	SR 290
Maple veneer	500.805.70	SR 290
Oak veneer	900.805.68	SR 290

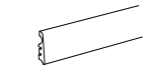

BALK skirting board, 200 cm.

Fasten to wall by using PLAN wall clips.

Brown	401.259.46	SR 45
Maple veneer	901.259.44	SR 45
Oak veneer	601.259.45	SR 45



KVIST wooden flooring with plastic strip system (strips included). 1.39 m²/pack.

Dark brown	501.106.14	SR 250
Light brown	400.808.77	SR 250



KVIST skirting board, 200 cm.

Fasten to wall by using PLAN wall clips.

Dark brown	201.259.47	SR 75
Light brown	001.259.48	SR 75



LÄKT wooden flooring with click system. 2.32 m²/pack.

Birch veneer	401.259.65	SR 289
Oak veneer	201.259.66	SR 289



LÄKT skirting board, 200 cm.

Fasten to wall by using PLAN wall clips.

Birch veneer	301.259.42	SR 45
Oak veneer	101.259.43	SR 45

Laminate flooring



HEMSE laminate flooring with click system.

2.66 m²/pack.

Oak stave effect	900.821.81	SR 175
------------------	------------	--------



TUNDRA laminate flooring with click system.

2.39 m²/pack.

Antique finish	600.700.14	SR 179
Maple effect	200.700.11	SR 179
Oak effect	800.700.13	SR 179
Oak effect medium brown	601.030.19	SR 179
Dark brown	201.370.78	SR 179
White	801.030.18	SR 140

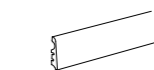

TUNDRA skirting board, 200 cm.

Fasten to wall by using PLAN wall clips.

Antique finish	001.259.34	SR 25
Maple effect	201.259.33	SR 25
Oak effect	801.259.30	SR 25
Oak effect medium brown	401.259.32	SR 25
White	601.259.31	SR 25
Dark brown	601.403.71	SR 25

Accessories

FIXA laying kit for laminate and wooden flooring.

1 kit incl. tapping block, crowbar and spacers.

	126.226.00	SR 29
--	------------	-------

SPÄRRA plastic sheeting.

To be used on concrete subflooring.

2.20x7.80 m	000.282.64	SR 99
-------------	------------	-------

NIVÅ floor lining. To be used on all types of subflooring.

3 mm polyethylene

	000.180.76	SR 125
--	------------	--------

PLAN skirting board, 200 cm.

Attach to wall by using PLAN wall clips.

White	801.259.49	SR 19
-------	------------	-------

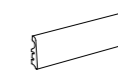

PLAN wall clip for skirting boards.

20-pack	801.259.25	SR 25
---------	------------	-------



PLAN quarterround profile, 200 cm.

Fibreboard*

	401.259.27	SR 15
--	------------	-------

White	201.259.28	SR 15
-------	------------	-------



PLAN multi profile, 95 cm.

Aluminium	601.259.26	SR 59
-----------	------------	-------

* Untreated fibreboard should be treated with paint or finish for a more durable and easy-to-clean surface.

HOW MUCH DO YOU NEED?

In the number of packs required, we have included one additional pack to ensure you have enough for your floor.

If you have too many, you can return them to the store, as long as they are un-opened.

Size of the room	6 m ²	9 m ²	12 m ²	15 m ²	20 m ²	25 m ²	30 m ²
Dampness block for concrete floors:							
SPÄRRA plastic sheeting (17 m ² /roll)	1 roll	1 roll	1 roll	1 roll	2 rolls	2 rolls	2 rolls
Underlay for all subfloors:							
NIVÅ 3,0 mm (15 m ² /roll)	1 roll	1 roll	1 roll	1 roll	2 rolls	2 rolls	2 rolls
NIVÅ 4,0 mm (7 m ² /pack)	1 pk	2 pks	2 pks	3 pks	3 pks	4 pks	5 pks
Wooden floors:							
BALK (1.55 m ² /pack)	5 pks	7 pks	9 pks	11 pks	14 pks	18 pks	21 pks
KVIST (1.39 m ² /pack)	6 pks	8 pks	10 pks	12 pks	16 pks	19 pks	23 pks
LÄKT (2.32 m ² /pack)	4 pks	5 pks	7 pks	8 pks	10 pks	12 pks	14 pks
Laminate floors:							
HEMSE (2.66 m ² /pack)	4 pks	5 pks	6 pks	7 pks	9 pks	11 pks	13 pks
TUNDRA (2.39 m ² /pack)	4 pks	5 pks	7 pks	8 pks	10 pks	12 pks	14 pks

HOW TO CARE FOR YOUR FLOOR

1. Use a vacuum cleaner or a damp, well-wrung mop.
2. You only need an ordinary cleaning agent in the water for normal cleaning.
3. Do not use a cleaning agent or care products containing wax, oil or polish.
4. Water must be mopped up immediately.
5. For areas exposed to lots of dirt, e.g. the hall, use a doormat to protect the floor.