

TRÄBY STORAGE SYSTEM

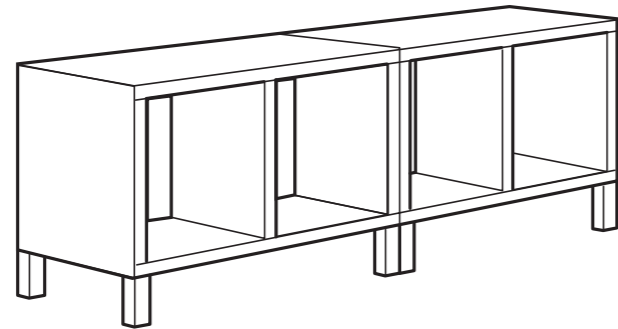
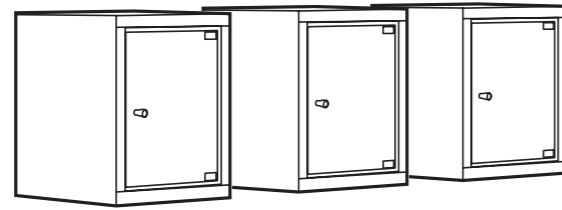

This combination

SR 1345

Matching wall shelf and bench. With TRÄBY storage series you can design your own matching wall-mounted shelf and storage units. Protect and display ornaments, CDs, etc. safe from dust behind glass doors. Use open shelves for storing magazines, games and other things you and the children use a lot. The legs make it easier to keep the floor clean under and around your storage.

Modern art

Each frame in the TRÄBY storage series is unique. They're made of brushed, oiled ash veneer, which has natural shifts in colour. By combining different sizes, you can easily create a personal solution with room for all your things. Hang them directly on the wall or put the frames on legs and place them on the floor. If you want to hide your things behind doors, complement with glass doors or drawer fronts and doors in wood. The final result is a functional piece of modern art.

TRÄBY COMBINATIONS





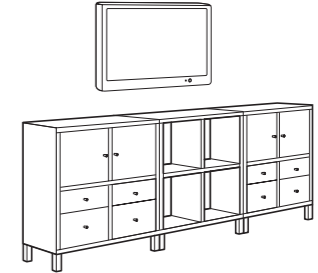



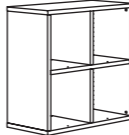

Fit doors and drawers wherever you want. Glass doors, veneered doors. Shallow drawers, deep drawers. It's up to you where you put them. That way you can design a solution with concealed and open storage customised to your needs – and add a distinctively personal touch at the same time.
Total size: 160x160x39 cm
This combination SR 1990

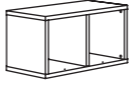

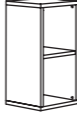
Keep control of your remotes. Create your own practical and personalised TV bench with TRÄBY storage series. With remote controls in one drawer and films in another or stored behind doors, it's easy to find what you want when you need it. Remove one of the dividing walls and you even have room for a DVD or video player.
Total size: 240x93x39 cm
This combination SR 1950

TRÄBY ALL THE PARTS AND PRICES

	ARTICLE NUMBER	PRICE	QUANTITY/TOTAL		ARTICLE NUMBER	PRICE	QUANTITY/TOTAL
	Shelf unit 80x80 cm.				Door 35x35 cm.		
	Ash veneer	901.050.69	SR 345		Ash veneer	601.050.61	SR 50
	Shelf unit 80x41 cm.				Glass door 35x35 cm.		
	Ash veneer	101.050.68	SR 275		Ash veneer	801.050.60	SR 60
	Shelf unit 41x80 cm.				Drawer 35 cm, 2-p.		
	Ash veneer	701.050.70	SR 275		Ash veneer	201.050.63	SR 145
	Shelf unit 41x41 cm.				Leg, height 13 cm, 4-p.		
	Ash veneer	501.050.71	SR 175		Ash veneer	501.142.35	SR 45

